

Data Sheet



Article number: 071061310200030

Description: Cardan drive shaft 0.106.131.002
S=200 X=30 Bore with keyway

Measures

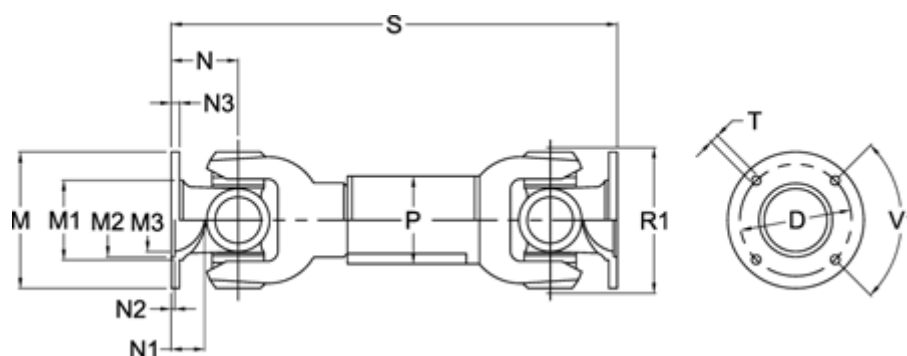

D	= 62 +-0,1	N1	= 15	T	= 6 B12
Extension X	= 30	N2	= 2,2 +0,3	V1 degrees	= 60
Flange diameter M	= 75	N3	= 5.5		
M1	= 46	Number og Flangeholes	= 6		
M2	= 42	P	= 32x1,5		
M3	= 36	R1	= 60		
Max. Bending Angle degrees	= 20	S min	= 200		
N	= 32	Spline dim. DIN 5480	= 25x1,5x15		